

CURRENT ELECTRICITY

1. ELECTRIC CURRENT

“The flow of charge in a definite direction constitutes the electric current and the time rate of flow of charge through any cross-section of a conductor is the measure of current”.
i.e.,

$$\text{Electric current, } I = \frac{\text{net charge flown}}{\text{time taken}} = \frac{q}{t} = \frac{dq}{dt}$$

1. Though the “electric current represents the direction of flow of positive charge”.
2. Yet it is treated as a scalar quantity.
3. Current follows, the laws of scalar addition and not the laws of vector addition.
4. Because the angle between the wires carrying currents does not affect the total current in the circuit.

2. CURRENT CARRIERS

(a) Current carriers in solid conductors :

1. In solid conductors like metals, the valence electrons of the atoms do not remain attached to individual atoms but are free to move throughout the volume of the conductor.
2. Under the effect of an external electric field, the valence electrons move in a definite direction causing electric current in the conductors.
3. Thus, valence electrons are the current carriers in solid conductors.

(b) Current carriers in liquids :

1. In an electrolyte like CuSO_4 , NaCl etc., there are positively and negatively charged ions (like Cu^{++} , SO_4^{-} , Na^+ , Cl^-).
2. These are forced to move in definite directions under the effect of an external electric field, causing electric current.
3. Thus, in liquids, the current carriers are positively and negatively charged ions.

(c) Current carriers in gases :

1. Ordinarily, the gases are insulators of electricity.
2. They can be ionized by applying a high potential difference at low pressure
3. Thus, positive ions and electrons are the current carriers in gases.

3. DRIFT VELOCITY

“If $\vec{u}_1, \vec{u}_2, \vec{u}_3, \dots, \vec{u}_n$ are random thermal velocities of n free electrons in the metal conductor, then the average thermal velocity of electrons is

$$\frac{\vec{u}_1 + \vec{u}_2 + \vec{u}_3 + \dots + \vec{u}_n}{n} = \vec{0}$$

As a result, there will be no net flow of electrons of charge in one particular direction in a metal conductor, hence no current”.

“Drift velocity is defined as the average velocity with which the free electrons get drifted towards the positive end of the conductor under the influence of an external electric field applied”.

1. The drift velocity of electrons is of the order of 10^{-4} ms^{-1} .
2. If V is the potential difference applied across the ends of the conductor of length l , the magnitude of electric field set up is

$$E = \frac{\text{Potential difference}}{\text{length}} = \frac{V}{l}$$

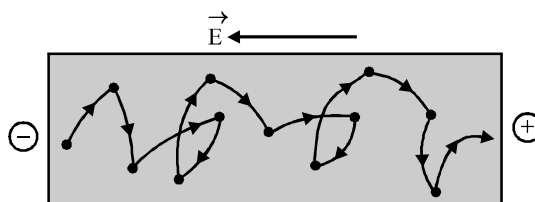

3. Each free electrons in the conductor experience a force,
 $\vec{F} = -e\vec{E}$.
4. The acceleration of each electron is
 $\vec{a} = \frac{e\vec{E}}{m}$.
5. At any instant of time, the velocity acquired by electron having thermal velocity \vec{u}_1 will be

$$\vec{v}_1 = \vec{u}_1 + \vec{a}\tau_1$$

where τ_1 is the time elapsed since it has suffered its last collision with ion/atom of the conductor.



6. Similarly, the velocities acquired by other electrons in the conductor will be

$$\vec{v}_2 = \vec{u}_2 + \vec{a}\tau_2, \quad \vec{v}_3 = \vec{u}_3 + \vec{a}\tau_3, \dots, \quad \vec{v}_n = \vec{u}_n + \vec{a}\tau_n.$$

7. The average velocity of all the free electrons in the conductor under the effect of external electric field is the drift velocity \vec{v}_d of the free electrons.

$$\begin{aligned} \text{Thus, } \vec{v}_d &= \frac{\vec{v} + \vec{v}_2 + \dots + \vec{v}_n}{n} \\ &= \frac{(\vec{u} + \vec{a}\tau_1) + (\vec{u}_2 + \vec{a}\tau_2) + \dots + (\vec{u}_n + \vec{a}\tau_n)}{n} \\ &= \left(\frac{\vec{u}_1 + \vec{u}_2 + \dots + \vec{u}_n}{n} \right) + \vec{a} \left(\frac{\tau_1 + \tau_2 + \dots + \tau_n}{n} \right) = 0 + \vec{a}\tau = \vec{a}\tau \end{aligned}$$

where, $\tau = \frac{\tau_1 + \tau_2 + \dots + \tau_n}{n}$ = average time that has elapsed

since each electron suffered its last collision with the ion/atom of conductor and is called average relaxation time.

8. Its value is the order of 10^{-14} second.

9. Putting the value of \vec{a} in the above relation, we have

$$\vec{v}_d = \frac{-e\vec{E}\tau}{m}$$

$$\text{Average drift speed, } v_d = \frac{eE}{m}\tau$$

The negative sign show that \vec{v}_d is opposite to the direction of \vec{E} .

3.1 Relaxation time (τ)

The time interval between two successive collisions of electrons with the positive ions in the metallic lattice is defined

as relaxation time $\tau = \frac{\text{mean free path}}{\text{r.m.s. velocity of electrons}} = \frac{\lambda}{v_{rms}}$. With

rise in temperature v_{rms} increases consequently τ decreases.

3.2 Mobility

Drift velocity per unit electric field is called mobility of electron *i.e.*

$$\mu = \frac{v_d}{E} \text{ It's unit is } \frac{\text{m}^2}{\text{volt} - \text{sec}}$$

• If cross-section is constant, $I \propto J$ *i.e.* for a given cross-sectional area, greater the current density, larger will be current.

• The drift velocity of electrons is small because of the frequent collisions suffered by electrons.

• The small value of drift velocity produces a large amount of electric current, due to the presence of extremely large number of free electrons in a conductor. The propagation of current is almost at the speed of light and involves electromagnetic process. It is due to this reason that the electric bulb glows immediately when switch is on.

• In the absence of electric field, the paths of electrons between successive collisions are straight line while in presence of electric field the paths are generally curved.

• Free electron density in a metal is given by $n = \frac{N_A \times d}{A}$

where N_A = Avogadro number, x = number of free electrons per atom, d = density of metal and A = Atomic weight of metal.

1. Mobility of charge carrier (μ), responsible for current is defined as the magnitude of drift velocity of charge per unit electric field applied, *i.e.*,

$$\mu = \frac{\text{drift velocity}}{\text{electric field}} = \frac{v_d}{E} = \frac{qE\tau/m}{E} = \frac{q\tau}{m}$$

2. Mobility of electron, $\mu_e = \frac{e\tau_e}{m_e}$

3. The total current in the conducting material is the sum of the currents due to positive current carriers and negative current carriers.

$$v_d = \mu_e E$$

4. SI unit of mobility is $\text{m}^2\text{S}^{-1}\text{V}^{-1}$ or $\text{ms}^{-1}\text{N}^{-1}\text{C}$

3.3 Relation between current and Drift Velocity

1. Consider a conductor (say a copper wire) of length l and of uniform area of cross-section

\therefore Volume of the conductor = Al .

2. If n is the number density of electrons, *i.e.*, the number of free electrons per unit volume of the conductor, then total number of free electrons in the conductor = An .

3. Then total charge on all the free electrons in the conductor,

$$q = A\ell ne$$

4. The electric field set up across the conductor is given by $E = V/l$ (in magnitude)

5. Due to this field, the free electrons present in the conductor will begin to move with a drift velocity v_d towards the left hand side as shown in figure

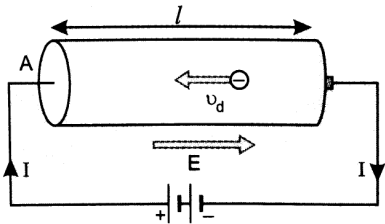

6. Time taken by the free electrons to cross the conductors, $t = l/v_d$

Hence, current,
$$dI = \frac{q}{t} = \frac{A \ell n e}{t = \frac{\ell}{v_d}}$$

or
$$I = A n e v_d$$

7. Putting the value of $v_d \left(= \frac{e E \tau}{m} \right)$, we have

$$I = \frac{A n e^2 \tau E}{m}$$

4. OHM'S LAW

Ohm's law states that the current (I) flowing through a conductor is directly proportional to the potential difference (V) across the ends of the conductor.

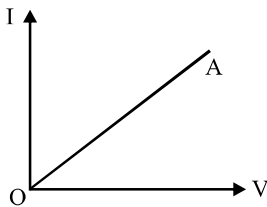

i.e., $I \propto V$ or $V \propto I$ or $V = RI$

or
$$\frac{V}{I} = R = \text{constant}$$

4.1 Deduction of Ohm's law

We know that $v_d = \frac{eE}{m} \tau$

But $E = V/l \therefore v_d = \frac{eV}{m \ell} \tau$

Also, $I = A n e v_d$

$$\therefore I = A n e \left(\frac{eV}{m \ell} \tau \right) = \left(\frac{A n e^2 \tau}{m \ell} \right) V$$

or
$$\frac{V}{I} = \frac{m \ell}{A n e^2 \tau} = R = \text{a constant for a given conductor for a given value of } n, l \text{ and at a given temperature. It is known as the electrical resistance of the conductor.}$$

Thus, $V = RI$

this is Ohm's law.

- Ohm's law is not a universal law, the substances, which obey Ohm's law are known as ohmic substance.
- Graph between V and i for a metallic conductor is a straight line as shown. At different temperatures V - i curves are different.

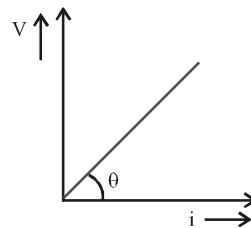

(A) Slope of the line

$$= \tan \theta = \frac{V}{i} = R$$

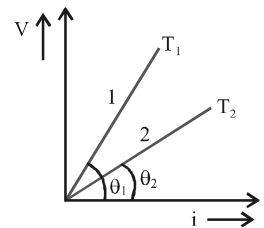

(B) Here $\tan \theta_1 > \tan \theta_2$

So, $R_1 > R_2$ i.e., $T_1 > T_2$

- The device or substances which don't obey Ohm's law e.g. gases, crystal rectifiers, thermionic valve, transistors etc. are known as non-ohmic or non-linear conductors. For these V - i curve is not linear.

Static resistance $R_{st} = \frac{V}{i} = \frac{1}{\tan \theta}$

Dynamic resistance $R_{dyn} = \frac{\Delta V}{\Delta I} = \frac{1}{\tan \phi}$

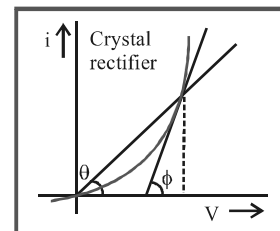

5. ELECTRICAL RESISTANCE

"The electrical resistance of a conductor is the obstruction posed by the conductor to the flow of electric current through it".

- i.e., $R = V/I$

2. The SI unit of electrical resistance is ohm or $\frac{\text{volt}}{\text{amp}}$.

3. **Dimensions of electric resistance**

$$= \frac{\text{Pot. diff.}}{\text{current}} = \frac{\text{work done/charge}}{\text{current}}$$

$$= \frac{ML^2T^{-2}/AT}{A} = [M^1 L^2 T^{-3} A^{-2}]$$

5.1 Electrical, Resistivity or Specific Resistance

“The resistance of a conductor depends upon the following factors :

- (i) **Length (l)** : The resistance (R) of a conductor is directly proportional to its length (l), i.e., $R \propto l$
- (ii) **Area of cross-section (A)** : The resistance (R) of a conductor is inversely proportional to the area of cross-section (A). of the conductor, i.e., $R \propto 1/A$
- (iii) The resistance of conductor also depends upon the **nature of material** and temperature of the conductor.

From above ; $R \propto \frac{l}{A}$ or $R = \frac{\rho l}{A}$.”

5.2 Resistivity (ρ)

- 1 Where ρ is constant of proportionality and is known as specific resistance or electrical resistivity of the material of the conductor
- 2. **Specific resistance** (or electrical resistivity) of the material of a conductor is defined as the resistance of a unit length with unit areas of cross section of the material of the conductor.

- (i) Unit and dimension : It’s S.I. unit is *ohm × m* and dimension is $[ML^3T^{-3}A^{-2}]$
- (ii) It’s formula : $\rho = \frac{m}{ne^2\tau}$
- (iii) Resistivity is the intrinsic property of the substance. It is independent of shape and size of the body (i.e. l and A).
- (iv) For different substances their resistivity is also different e.g. $\rho_{\text{silver}} = \text{minimum} = 1.6 \times 10^{-8} \Omega\text{-m}$ and $\rho_{\text{fused quartz}} = \text{maximum} \approx 10^{16} \Omega\text{-m}$

$$\rho_{\text{insulator}} > \rho_{\text{alloy}} > \rho_{\text{semi-conductor}} > \rho_{\text{conductor}}$$

(Maximum for fused quartz) (Minimum for silver)

- (v) Resistivity depends on the temperature. For metals $\rho_t = \rho_0(1 + \alpha\Delta t)$ i.e. resistivity increases with temperature.

- (vi) Resistivity increases with impurity and mechanical stress.
- (vii) Magnetic field increases the resistivity of all metals except iron, cobalt and nickel.
- (viii) Resistivity of certain substances like selenium, cadmium, sulphides is inversely proportional to intensity of light falling upon them.

3. We have, $R = \frac{V}{I} = \frac{m\ell}{Ane^2\tau} = \frac{m}{ne^2\tau} \times \frac{\ell}{A}$

comparing the above relation with the relation, $R = \rho \frac{\ell}{A}$.

- 4. We have, the resistivity of the material of a conductor,

$$\rho = \frac{m}{ne^2\tau}$$

5.3 Conductivity

Reciprocal of resistivity is called conductivity (σ) i.e. $\sigma = \frac{1}{\rho}$ with unit *mho/m* and dimensions $[M^{-1}L^{-3}T^3A^2]$.

5.4 Conductance

Reciprocal of resistance is known as conductance. $C = \frac{1}{R}$ It’s unit is $\frac{1}{\Omega}$ or Ω^{-1} or “Siemen”.

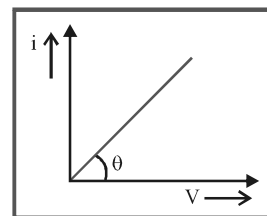

5.5 Stretching of Wire

If a conducting wire stretches, it’s length increases, area of cross-section decreases so resistance increases but volume remain constant.

Suppose for a conducting wire before stretching it’s length = l_1 , area of cross-section = A_1 , radius = r_1 , diameter = d_1 , and

resistance = $R_1 = \rho \frac{l_1}{A_1}$

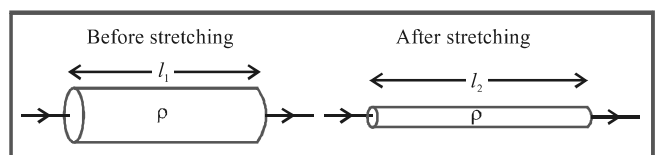

Volume remains constant i.e., $A_1 l_1 = A_2 l_2$
 After stretching length = l_2 , area of cross-section = A_2 ,

radius = r_2 , diameter = d_2 and resistance = $R_2 = \rho \frac{l_2}{A_2}$

Ratio of resistances before and after stretching

$$\frac{R_1}{R_2} = \frac{l_1 \times A_2}{l_2 \times A_1} = \left(\frac{l_1}{l_2}\right)^2 = \left(\frac{A_2}{A_1}\right)^2 = \left(\frac{r_2}{r_1}\right)^4 = \left(\frac{d_2}{d_1}\right)^4$$

(1) If length is given then $R \propto l^2 \Rightarrow \frac{R_1}{R_2} = \left(\frac{l_1}{l_2}\right)^2$

(2) If radius is given then $R \propto \frac{1}{r^4} \Rightarrow \frac{R_1}{R_2} = \left(\frac{r_2}{r_1}\right)^4$

6. CURRENT DENSITY, CONDUCTANCE AND ELECTRICAL CONDUCTIVITY

6.1 Relation between J, σ and E

We know, $I = n A e v_d = n A e \left(\frac{eE}{m} \tau\right) = \frac{n A e^2 \tau E}{m}$

or $\frac{I}{A} = \frac{n e^2 \tau E}{m}$ or $J = \frac{1}{\rho} E$

$\therefore \boxed{J = \sigma E}$

1. **Insulators** : These are those materials whose electrical conductivity is either very very small or nil.

Insulators do not conduct charges. When a small potential difference is applied across the two ends of an insulator, the current through the insulator is zero.

Examples of insulators are glass, rubber, wood etc.

Variation of R, ρ with T

2. **Conductors** : These are those materials whose electrical conductivity is very high

Conductor conduct charges very easily. When a small potential difference is applied across the two ends of conductor, a strong current flows through the conductor. For super-conductor, the value of electrical conductivity is infinite and electrical resistivity is zero.

Examples of conductors are all metals like copper, silver, aluminium, tungsten etc.

3. **Semiconductors** : These are those material whose electrical conductivity lies inbetween that of insulators and conductors. Semiconductors can conduct charges but not so easily as is in case of conductors. When a small potential difference is applied across the ends of a semiconductor, a weak current flows through semiconductor due to motion of electrons and holes.

Examples of semiconductors are germanium, silicon etc.

The value of electrical resistance R increases with rise of temperature.

$$\alpha = \frac{R_t - R_0}{R_0 \times t} = \frac{\text{increase in resistance}}{\text{original resistance} \times \text{rise of temp.}}$$

Thus, temperature coefficient of resistance is defined as the increase in resistance per unit original resistance per degree celsius or kelvin rise of temperature.

1. **For metals** like silver, copper, etc., the value of α is positive, therefore, resistance of a metal increases with rise in temperature. The unit of α is K^{-1} or $^{\circ}C^{-1}$.
2. **For insulators and semiconductors** α is negative, therefore, the resistance decreases with rise in temperature.

6.2 Non-Ohmic Devices

Those devices which do not obey Ohm's law are called non-ohmic devices. For example, vacuum tubes, semiconductor diode, liquid electrolyte, transistor etc.

For all **non-ohmic devices** (where there will be failure of Ohm's law), V-I graph has one or more of the following characteristics :

- (a) The relation between V and I is **non-linear**, figure

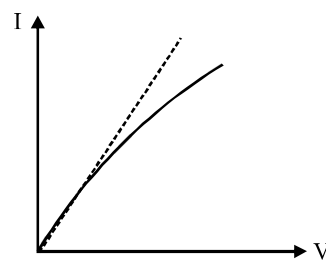

- (b) The relation between V and I **depends on the sign of V**. It means, if I is the current for a certain value of V, then reversing the direction of V, keeping its magnitude fixed, does not produce a current of same magnitude I, in the opposite direction, figure.

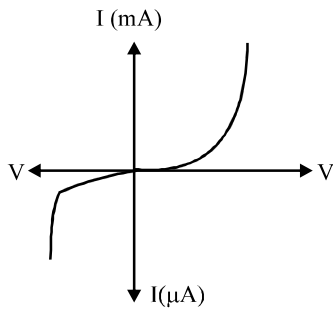

(c) The relation between V and I is not unique, i.e., there is more than one value of V for the same current I , figure.

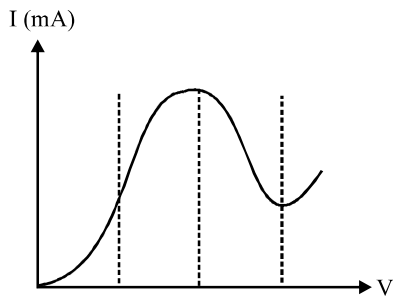

7. COLOUR CODE FOR CARBON RESISTORS

The colour code for carbon resistance is given in the following table.

Colour code of carbon resistors

Colour	Letter as an Aid to memory	No.	Multplier	Colour	Tolerance
Black	B	0	10^0	Gold	5%
Brown	B	1	10^1	Silver	10%
Red	R	2	10^2	No colour	20%
Orange	O	3	10^3		
Yellow	Y	4	10^4		
Green		5	10^5		
Blue	B	6	10^6		
Violet	V	7	10^7		
Grey		8	10^8		
White	W	9	10^9		
Gold			10^{-1}		
Silver			10^{-2}		

To remember the value of colour coding used for carbon resistor, the following sentences are found to be of great help (where bold letters stand for colours).

B B ROY Green, Britain Very Good Wife **Gold Silver**.

Way of finding the resistance of carbon resistor from its colour coding.

In the system of colour coding, Strips of different colours are given on the body of the resistor, figure. The colours on strips are noted from left to right.

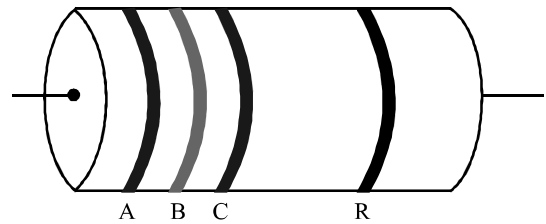

- (i) Colour of the first strip **A** from the end indicates the first significant figure of resistance in ohm.
- (ii) Colour of the second strip **B** indicate the second significant figure of resistance in ohm.
- (iii) The colour of the third strip **C** indicates the multiplier, i.e., the number of zeros that will follow after the two significant figure.
- (iv) The colour of fourth strip **R** indicates the tolerance limit of the resistance value of percentage accuracy of resistance.

8. COMBINATION OF RESISTORS

8.1 Resistances in Series

Resistors are said to be connected in series, if the same current is flowing through each resistor when some potential difference is applied across the combination.

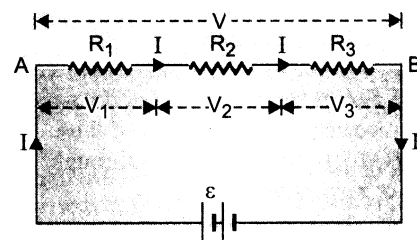

1. Let V be the potential difference applied across A and B using the battery ϵ . In series combination, the same current (say I) will be passing through each resistance.
2. Let V_1, V_2, V_3 be the potential difference across R_1, R_2 and R_3 respectively. According to Ohm's law
 $V_1 = IR_1, V_2 = IR_2, V_3 = IR_3$
3. Here, $V = V_1 + V_2 + V_3 = IR_1 + IR_2 + IR_3 = I(R_1 + R_2 + R_3)$

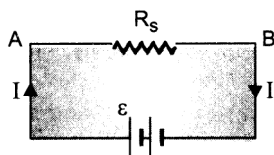

4. If R_s is the equivalent resistance of the given series combination of resistances, figure, then the potential difference across A and B is,

$$V = IR_s.$$

We have

$$IR_s = I(R_1 + R_2 + R_3)$$

or $R_s = R_1 + R_2 + R_3$

Memory note

In a series resistance circuit, it should be noted that :

- (i) the current is same in every resistor.
- (ii) the current in the circuit is independent of the relative positions of the various resistors in the series.
- (iii) the voltage across any resistor is directly proportional to the resistance of the resistor.
- (iv) the total resistance of the circuit is equal to the sum of the individual resistances, plus the internal resistance of a cell if any.
- (v) The total resistance in the series circuit is obviously more than the greatest resistance in the circuit.

8.2 Resistances in Parallel

Any number of resistors are said to be connected in parallel if potential difference across each of them is the same and is equal to the applied potential difference.

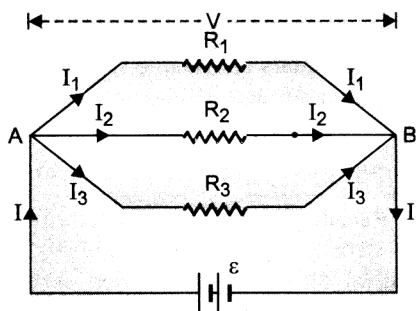

- 1. Let V be the potential difference applied across A and B with the help of a battery ϵ .
- 2. Let I be the main current in the circuit from battery. I divides itself into three unequal parts because the resistances of these

branches are different and I_1, I_2, I_3 be the current through the resistances R_1, R_2 and R_3 respectively. Then,

$$I = I_1 + I_2 + I_3$$

3. Here, potential difference across each resistor is V , therefore

$$V = I_1 R_1 = I_2 R_2 = I_3 R_3$$

or $I_1 = \frac{V}{R_1}, I_2 = \frac{V}{R_2}, I_3 = \frac{V}{R_3}$

Putting values, we get

$$I = \frac{V}{R_1} + \frac{V}{R_2} + \frac{V}{R_3}$$

4. If R_p is the equivalent resistance of the given parallel combination of resistance, figure, then

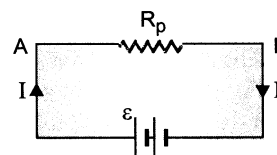

$$V = IR_p \text{ or } I = V/R_p$$

we have

$$\frac{V}{R_p} = \frac{V}{R_1} + \frac{V}{R_2} + \frac{V}{R_3} \text{ or } \frac{1}{R_p} = \frac{1}{R_1} + \frac{1}{R_2} + \frac{1}{R_3}$$

Thus, the reciprocal of equivalent resistance of a number of resistor connected in parallel is equal to the sum of the reciprocals of the individual resistances.

Memory note

In a parallel resistance circuit, it should be noted that :

- (i) the potential difference across each resistor is the same and is equal to the applied potential difference.
- (ii) the current through each resistor is inversely proportional to the resistance of that resistor.
- (iii) total current through the parallel combination is the sum of the individual currents through the various resistors.
- (iv) The reciprocal of the total resistance of the parallel combination is equal to the sum of the reciprocals of the individual resistances.
- (v) The total resistances are connected in series, the current through each resistance is same. When the resistance are in parallel, the pot-diff. across each resistance is the same and not the current.



9. CELL

The device which converts chemical energy into electrical energy is known as electric cell. Cell is a source of constant emf but not constant current.

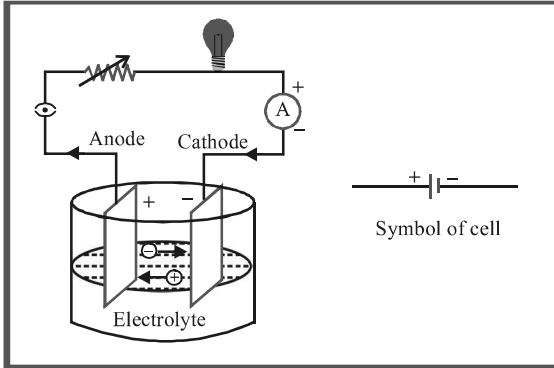

- (1) **Emf of cell (E)** : The potential difference across the terminals of a cell when it is not supplying any current is called its emf.
- (2) **Potential difference (V)** : The voltage across the terminals of a cell when it is supplying current to external resistance is called potential difference or terminal voltage. Potential difference is equal to the product of current and resistance of that given part *i.e.* $V = iR$.
- (3) **Internal resistance (r)** : In case of a cell the opposition of electrolyte to the flow of current through it is called internal resistance of the cell. The internal resistance of a cell depends on the distance between electrodes ($r \propto d$), area of electrodes [$r \propto (1/A)$] and nature, concentration ($r \propto C$) and temperature of electrolyte [$r \propto (1/\text{temp.})$]. A cell is said to be ideal, if it has zero internal resistance.

9.1 Cell in Various Positions

- (1) **Closed circuit** : Cell supplies a constant current in the circuit.

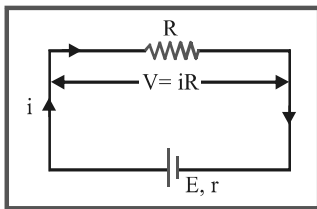

- (i) Current given by the cell $i = \frac{E}{R + r}$
- (ii) Potential difference across the resistance $V = iR$

- (iii) Potential drop inside the cell $= ir$
- (iv) Equation of cell $E = V + ir$ ($E > V$)
- (v) Internal resistance of the cell $r = \left(\frac{E}{V} - 1\right) \cdot R$
- (vi) Power dissipated in external resistance (load)

$$P = Vi = i^2R = \frac{V^2}{R} = \left(\frac{E}{R + r}\right)^2 \cdot R$$

Power delivered will be maximum when $R = r$ so $P_{\max} = \frac{E^2}{4r}$.

This statement in generalised form is called “*maximum power transfer theorem*”.

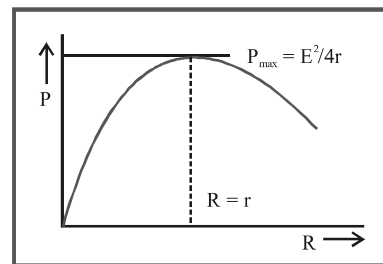

- (vii) When the cell is being charged *i.e.* current is given to the cell then $E = V - ir$ and $E < V$.
- (2) **Open circuit** : When no current is taken from the cell it is said to be in open circuit.

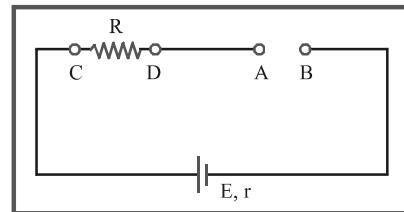

- (i) Current through the circuit $i = 0$
- (ii) Potential difference between A and B, $V_{AB} = E$
- (iii) Potential difference between C and D, $V_{CD} = 0$
- (3) **Short circuit** : If two terminals of cell are join together by a thick conducting wire

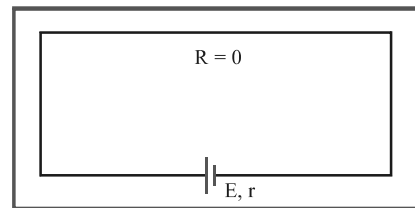

- (i) Maximum current (called short circuit current) flows momentarily $i_{sc} = \frac{E}{r}$

- (ii) Potential difference $V = 0$

Memory note

- It is important to note that during charging of a cell, the positive electrode of the cell is connected to positive terminal of battery charger and negative electrodes of the cell is connected to negative terminal of battery charger. In this process, current flows from positive electrode to negative electrode through the cell. Refer figure

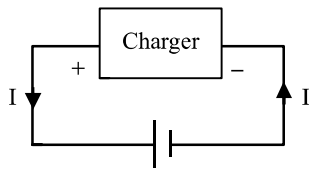

$\therefore V = \epsilon + Ir$

Hence, the terminal potential difference becomes greater than the emf of the cell.

- The difference of emf and terminal voltage is called lost voltage as it is not indicated by a voltmeter. It is equal to Ir .

9.2 Distinction between E.M.F. and Potential Difference

E.M.F. of a Cell	Potential Difference
1. The emf of a cells is the maximum potential difference between the two electrodes of a cell when the cell is in the open circuit.	1. The potential difference between the two points is the difference of potential between those two points in a closed circuit.
2. It is independent of the resistance of the circuit and depends upon the nature of electrodes and the nature of electrolyte of the cell.	2. It depends upon the resistance between the two points of the circuit and current flowing through the circuit.
3. The term emf is used for the source of electric current.	3. The potential difference is measured between any two points of the electric circuit.
4. It is a cause.	4. It is an effect.

9.3 Grouping of Cells

In series grouping of cell's their emf's are additive or subtractive while their internal resistances are always additive. If dissimilar

plates of cells are connected together their emf's are added to each other while if their similar plates are connected together their emf's are subtractive.

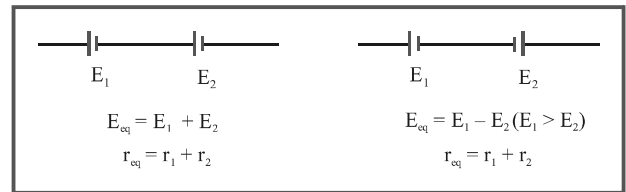

- (1) **Series grouping** : In series grouping anode of one cell is connected to cathode of other cell and so on. If n identical cells are connected in series

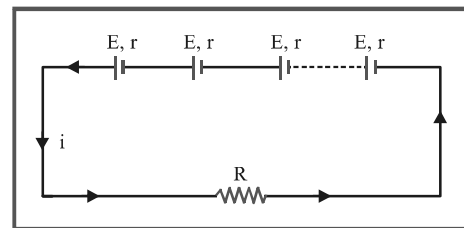

- Equivalent emf of the combination $E_{eq} = nE$
 - Equivalent internal resistance $r_{eq} = nr$
 - Main current = Current from each cell $i = \frac{nE}{R + nr}$
 - Potential difference across external resistance $V = iR$
 - Potential difference across each cell $V' = \frac{V}{n}$
 - Power dissipated in the external circuit $= \left(\frac{nE}{R + nr} \right)^2 \cdot R$
 - Condition for maximum power $R = nr$ and $P_{max} = n \left(\frac{E^2}{4r} \right)$
 - This type of combination is used when $nr \ll R$.
- (2) **Parallel grouping** : In parallel grouping all anodes are connected at one point and all cathode are connected together at other point. If n identical cells are connected in parallel

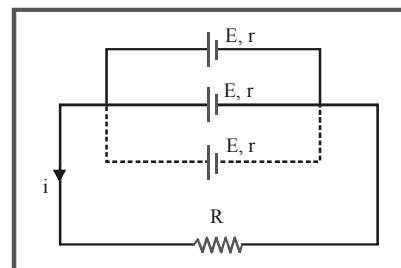



- (i) Equivalent emf $E_{eq} = E$
- (ii) Equivalent internal resistance $R_{eq} = r/n$
- (iii) Main current $i = \frac{E}{R + r/n}$
- (iv) Potential difference across external resistance = p.d. across each cell $= V = iR$
- (v) Current from each cell $i' = \frac{i}{n}$
- (vi) Power dissipated in the circuit $P = \left(\frac{E}{R + r/n}\right)^2 \cdot R$
- (vii) Condition for max. power is $R = r/n$ and $P_{max} = n \left(\frac{E^2}{4r}\right)$
- (viii) This type of combination is used when $nr \gg R$

- (iii) Main current flowing through the load

$$i = \frac{nE}{R + \frac{nr}{m}} = \frac{mnE}{mR + nr}$$

- (iv) Potential difference across load $V = iR$
- (v) Potential difference across each cell $V' = \frac{V}{n}$
- (vi) Current from each cell $i' = \frac{i}{n}$
- (vii) Condition for maximum power $R = \frac{nr}{m}$ and $P_{max} = (mn) \frac{E^2}{4r}$
- (viii) Total number of cell $= mn$

Generalized Parallel Battery

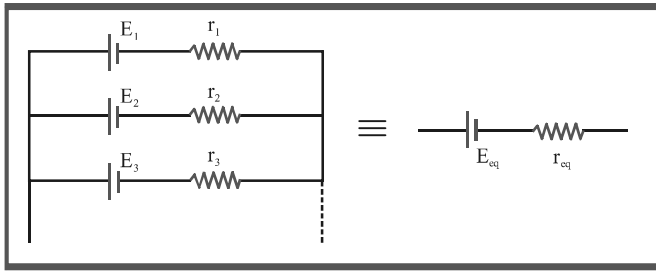

$$E_{eq} = \frac{\frac{E_1}{r_1} + \frac{E_2}{r_2} + \dots + \frac{E_n}{r_n}}{\frac{1}{r_1} + \frac{1}{r_2} + \dots + \frac{1}{r_n}} \text{ and } \frac{1}{r_{eq}} = \frac{1}{r_1} + \frac{1}{r_2} + \dots + \frac{1}{r_n}$$

- (3) **Mixed Grouping :** If n identical cell's are connected in a row and such m row's are connected in parallel as shown.

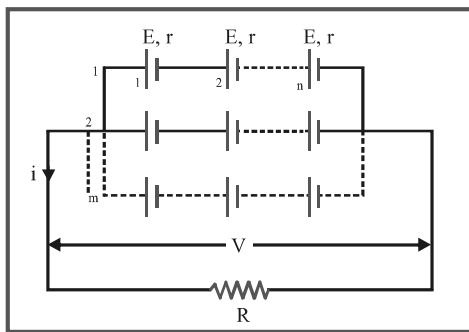

- (i) Equivalent emf of the combination $E_{eq} = nE$
- (ii) Equivalent internal resistance of the combination $r_{eq} = \frac{nr}{m}$

Memory note

Note that (i) If the two cells connected in parallel are of the same emf ϵ and same internal resistance r , then

$$\epsilon_{eq} = \frac{\epsilon r + \epsilon r}{r + r} = \epsilon$$

$$\frac{1}{r_{eq}} = \frac{1}{r} + \frac{1}{r} = \frac{2}{r} \text{ or } r_{eq} = \frac{r}{2}$$

- (ii) If n identical cells are connected in parallel, then the equivalent emf of all the cells is equal to the emf of one cell.

$$\frac{1}{r_{eq}} = \frac{1}{r} + \frac{1}{r} + \dots + n \text{ terms} = \frac{n}{r} \text{ or } r_{eq} = r/n$$

10. ELECTRIC CURRENT

- (1) The time rate of flow of charge through any cross-section is called current. $i = \lim_{\Delta t \rightarrow 0} \frac{\Delta Q}{\Delta t} = \frac{dQ}{dt}$. If flow is uniform then $i = \frac{Q}{t}$. Current is a scalar quantity. It's S.I. unit is ampere (A) and C.G.S. unit is emu and is called biot (Bi), or ab ampere. $1A = (1/10) \text{ Bi}$ (ab amp.)
- (2) Ampere of current means the flow of 6.25×10^{18} electrons/sec through any cross-section of the conductor.
- (3) The conventional direction of current is taken to be the direction of flow of positive charge, i.e. field and is

opposite to the direction of flow of negative charge as shown below.

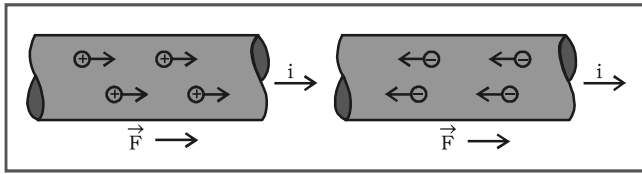

- (4) The net charge in a current carrying conductor is zero.
- (5) For a given conductor current does not change with change in cross-sectional area. In the following figure $i_1 = i_2 = i_3$

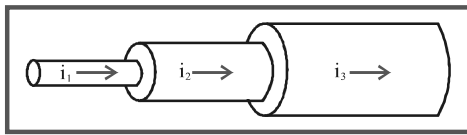

- (6) **Current due to translatory motion of charge :** If n particle each having a charge q , pass through a given area in time t then

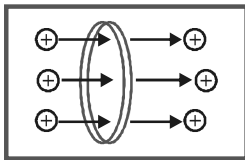

If n particles each having a charge q pass per second per unit area, the current associated with cross-sectional area A is $i = nqA$

If there are n particle per unit volume each having a charge q and moving with velocity v , the current thorough, cross section A is $i = nqvA$

- (7) **Current due to rotatory motion of charge :** If a point charge q is moving in a circle of radius r with speed v (frequency ν , angular speed ω and time period T) then

corresponding current $i = qv = \frac{q}{T} = \frac{qv}{2\pi r} = \frac{q\omega}{2\pi}$

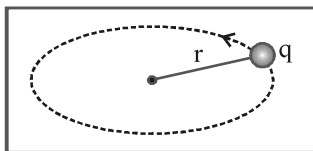

- (8) **Current carriers :** The charged particles whose flow in a definite direction constitutes the electric current are called current carriers. In different situation current carriers are different.

- (i) **Solids :** In solid conductors like metals current carriers are free electrons.
- (ii) **Liquids :** In liquids current carriers are positive and negative ions.
- (iii) **Gases :** In gases current carriers are positive ions and free electrons.
- (iv) **Semi conductor :** In semi conductors current carriers are holes and free electrons.
- (v) The amount of charge flowing through a cross-section of a conductor from $t = t_1$ to $t = t_2$ is given by :

$$q = \int_{t_1}^{t_2} I dt$$

From Graphs

- (i) Slope of Q vs t graph gives instantaneous current.

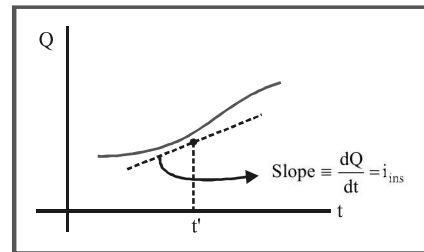

- (ii) Area under the I vs t graph gives net charge flown.

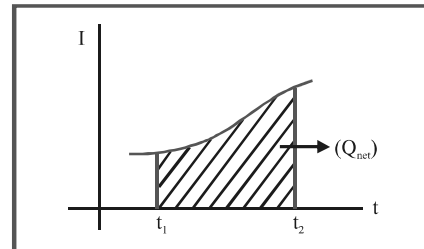

11. KIRCHHOFF'S LAW

11.1 Kirchhoff's first law or Kirchhoff's junction law or Kirchhoff's current law.

1. the algebraic sum of the currents meeting at a junction in a closed electric circuit is zero, i.e., $\sum I = 0$
2. Consider a junction O in the electrical circuit at which the five conductors are meeting. Let I_1, I_2, I_3, I_4 and I_5 be the currents in these conductors in directions, shown in figure,

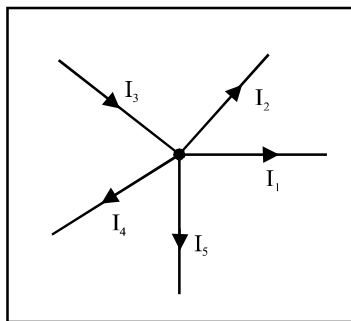

- Let us adopt the following sign convention : the current flowing in a conductor towards the junction is taken as positive and the current flowing away from the junction is taken as negative.
- According to Kirchhoff's first law, at junction O
 $(-I_1) + (-I_2) + I_3 + (-I_4) + I_5 = 0$
 or $-I_1 - I_2 + I_3 - I_4 + I_5 = 0$
 or $\sum I = 0$
 or $I_3 + I_5 = I_1 + I_2 + I_4$
- i.e., total current flowing towards the junction is equal to total current flowing out of the junction.
- Current cannot be stored at a junction. It means, no point/ junction in a circuit can act as a source or sink of charge.
- Kirchhoff's first law supports law of conservation of charge.**

11.2 Kirchhoff's Second law or Kirchhoff's loop law or Kirchhoff's voltage law.

The algebraic sum of changes in potential around any closed path of electric circuit (or closed loop) involving resistors and cells in the loop is zero, i.e., $\sum \Delta V = 0$.

In a closed loop, the algebraic sum of the emfs and algebraic sum of the products of current and resistance in the various arms of the loop is zero, i.e., $\sum \epsilon + \sum IR = 0$.

Kirchhoff's second law supports the law of conservation of energy, i.e., the net change in the energy of a charge, after the charge completes a closed path must be zero.

Kirchhoff's second law follows from the fact that the electrostatic force is a conservative force and work done by it in any closed path is zero.

Consider a closed electrical circuit as shown in figure, containing two cells of emfs, ϵ_1 and ϵ_2 and three resistors of resistances R_1 , R_2 and R_3 .

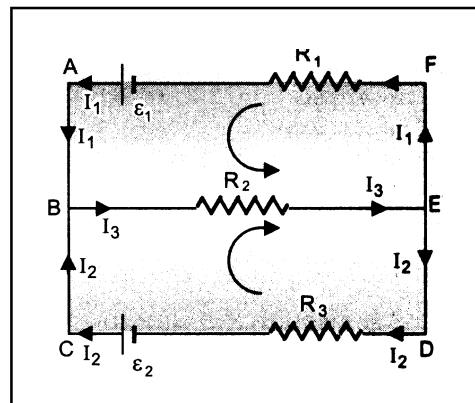

We adopt the following sign convention :

Traverse a closed path of a circuit once completely in clockwise or anticlockwise direction.

Difference between Kirchhoff's I and II laws

First Law	Second Law
1. This law supports the law of conservation of charge.	1. This law supports the law of conservation of energy.
2. According to this law $\sum I = 0$.	2. According to this law $\sum \epsilon = \sum IR$
3. This law can be used in open and closed circuits.	3. This law can be used in closed circuit only.

12. EXPERIMENTS

12.1 Galvanometer

It is an instrument used to detect small current passing through it by showing deflection. Galvanometers are of different types e.g. moving coil galvanometer, moving magnet galvanometer, hot wire galvanometer. In dc circuit usually moving coil galvanometer are used.

- It's symbol :** ; where G is the total internal resistance of the galvanometer.
- Full scale deflection current :** The current required for full scale deflection in a galvanometer is called full scale deflection current and is represented by i_g .
- Shunt :** The small resistance connected in parallel to galvanometer coil, in order to control current flowing through the galvanometer is known as shunt.

Table : Merits and demerits of shunt

Merits of shunt	Demerits of shunt
To protect the galvanometer coil from burning . It can be used to convert any galvanometer into ammeter of desired range.	Shunt resistance decreases the sensitivity of galvanometer.

12.2 Ammeter

It is a device used to measure current and is always connected in series with the 'element' through which current is to be measured.

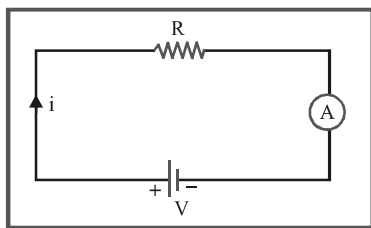

- (i) The reading of an ammeter is always lesser than actual current in the circuit.
- (ii) Smaller the resistance of an ammeter more accurate will be its reading. An ammeter is said to be ideal if its resistance r is zero.
- (iii) **Conversion of galvanometer into ammeter :** A galvanometer may be converted into an ammeter by connecting a low resistance (called shunt S) in parallel to the galvanometer G as shown in figure.

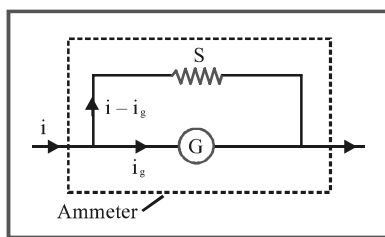

- (a) Equivalent resistance of the combination $= \frac{GS}{G+S}$
- (b) G and S are parallel to each other hence both will have equal potential difference i.e. $i_g G = (i - i_g) S$; which gives

$$\text{Required shunt } S = \frac{i_g}{(i - i_g)} G$$

- (c) To pass n th part of main current (i.e. $i_g = \frac{i}{n}$) through the galvanometer, required shunt $S = \frac{G}{(n-1)}$.

12.3 Voltmeter

It is a device used to measure potential difference and is always put in parallel with the 'circuit element' across which potential difference is to be measured.

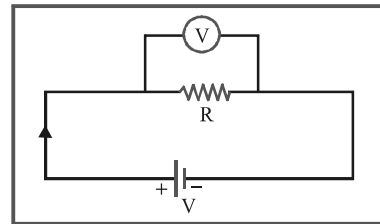

- (i) The reading of a voltmeter is always lesser than true value.
- (ii) Greater the resistance of voltmeter, more accurate will be its reading. A voltmeter is said to be ideal if its resistance is infinite, i.e., it draws no current from the circuit element for its operation.
- (iii) **Conversion of galvanometer into voltmeter :** A galvanometer may be converted into a voltmeter by connecting a large resistance R in series with the galvanometer as shown in the figure.

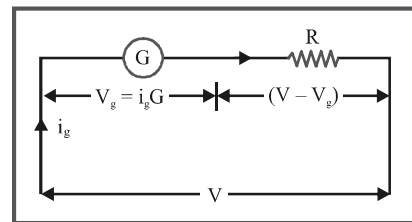

- (a) Equivalent resistance of the combination $= G + R$
- (b) According to ohm's law Maximum reading of V which can be taken $V = i_g (G + R)$; which gives

$$\text{Required series resistance } R = \frac{V}{i_g} - G = \left(\frac{V}{V_g} - 1 \right) G$$

- (c) If n th part of applied voltage appeared across galvanometer (i.e. $V_g = \frac{V}{n}$) then required series resistance $R = (n - 1) G$.

12.4 Wheatstone Bridge Principle

Wheatstone Bridge Principle states that if four resistances P, Q, R and S are arranged to form a bridge as shown in figure, if galvanometer shows no deflection, the bridge is balanced.

In that case

$$\frac{P}{Q} = \frac{R}{S}$$

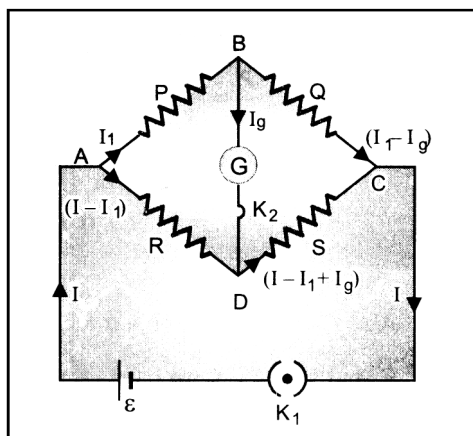

Proof :

Let I be the total current given out by the cell. On reaching the point A , it is divided into two parts :

1. I_1 is flowing through P
2. $(I - I_1)$ through R .

At B , the current I_1 is divided into two parts, I_g through the galvanometer G and $(I_1 - I_g)$ through Q .

A current $(I - I_1 + I_g)$ through S .

Applying Kirchhoff's Second Law to the closed circuit $ABDA$, we get

$$I_1 P + I_g G - (I - I_1) R = 0 \quad \dots(1)$$

where G is the resistance of galvanometer.

Again applying Kirchhoff's Second Law to the closed circuit $BCDB$, we get

$$(I_1 - I_g) Q - (I - I_1 + I_g) S - I_g G = 0 \quad \dots(2)$$

The value of R is adjusted such that the galvanometer shows no deflection, i.e., $I_g = 0$. Now, the bridge is balanced. Putting $I_g = 0$ in (1) and (2) we have

$$I_1 P - (I - I_1) R = 0 \quad \text{or} \quad I_1 P = (I - I_1) R \quad \dots(3)$$

and $I_1 Q - (I - I_1) S = 0 \quad \text{or} \quad I_1 Q = (I - I_1) S \quad \dots(4)$

Dividing (3) by (4), we get $\frac{P}{Q} = \frac{R}{S}$

Note that in Wheatstone bridge circuit, arms AB and BC having resistances P and Q form ratio arm. The arm AD , having a resistance R , is a known variable resistance arm and arm DC , having a resistance S is unknown resistance arm.

- (i) **Balanced bridge :** The bridge is said to be balanced when deflection in galvanometer is zero i.e. no current flows

through the galvanometer or in other words $V_B = V_D$. In the

balanced condition $\frac{P}{Q} = \frac{R}{S}$, on mutually changing the

position of cell and galvanometer this condition will not change.

- (ii) **Unbalanced bridge :** If the bridge is not balanced current will flow from D to B if $V_D > V_B$ i.e. $(V_A - V_D) < (V_A - V_B)$ which gives $PS > RQ$.
- (iii) **Applications of wheatstone bridge :** Meter bridge, post office box and Carey Foster bridge are instruments based on the principle of wheatstone bridge and are used to measure unknown resistance.

12.5 Slide Wire Bridge or Meter Bridge

A slide wire bridge is a practical form of Wheatstone bridge.

It consists of a wire AC of constantan or manganin of 1 metre length and of uniform area of cross-section.

A meter scale is also fitted on the wooden board parallel to the length of the wire.

Copper strip fitted on the wooden board in order to provide two gaps in strips.

Across one gap, a resistance box R and in another gap the unknown resistance S are connected.

The positive pole of the battery E is connected to terminal A and the negative pole of the battery to terminal C through one way key K .

The circuit is now exactly the same as that of the Wheatstone bridge figure.

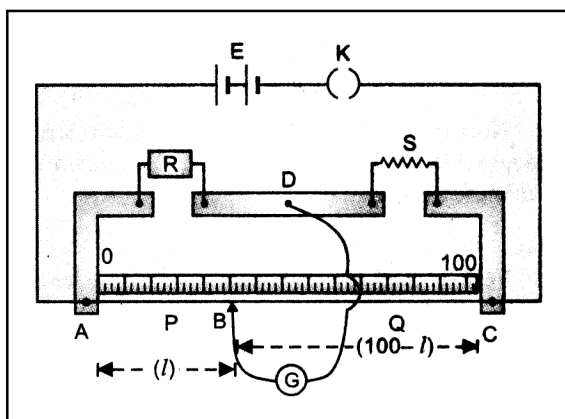

Adjust the position of jockey on the wire (say at B) where on pressing, galvanometer shows no deflection.

Note the length AB ($= l$ say) to the wire. Find the length BC ($= 100 - l$) of the wire.

According to Wheatstone bridge principle

$$\frac{P}{Q} = \frac{R}{S}$$

If r is the resistance per cm length of wire, then

P = resistance of the length l of the wire $AB = lr$

Q = resistance of the length $(100-l)$ of the wire $BC = (100-l)r$.

$$\therefore \frac{lr}{(100-l)r} = \frac{R}{S} \text{ or } S = \left(\frac{100-l}{l}\right) \times R$$

Knowing l and R , we can calculate S .

12.6 Potentiometer and its principle of working

Potentiometer is an apparatus used for measuring the emf of a cells or potential difference between two points in an electrical circuit accurately.

A potentiometer consists of a long uniform wire generally made of manganin or constantan, stretched on a wooden board.

Its ends are connected to the binding screws A and B. A meter scale is fixed on the board parallel to the length of the wire. The potentiometer is provided with a jockey J with the help of which, the contact can be made at any point on the wire, figure. A battery ϵ (called driving cell), connected across A and B sends the current through the wire which is kept constant by using a rheostat R_h .

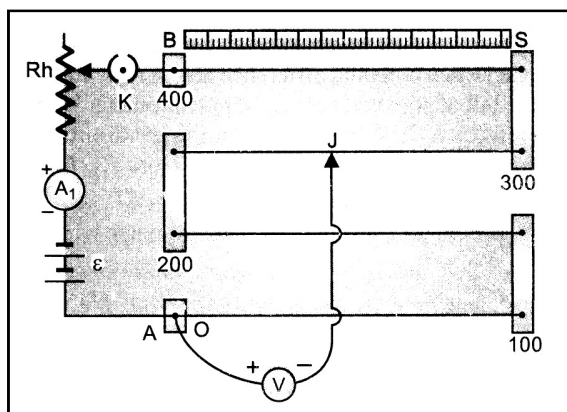

Principle : The working of a potentiometer is based on the fact that the fall of potential across any portion of the wire is directly proportional to the length of that portion provided the wire is of uniform area of cross-section and a constant current is flowing through it.

Suppose A and ρ are respectively the area of cross-section and specific resistance of the material of the wire.

Let V be the potential difference across the portion of the wire of length l whose resistance is R .

If I is the current flowing through the wire, then from Ohm's law; $V = IR$; As, $R = \rho l/A$

$$\therefore V = I\rho \frac{l}{A} = Kl, \quad \left(\text{where } K = \frac{I\rho}{A}\right)$$

or $V \propto l$ (if I and A are constant)

i.e., potential difference across any portion of potentiometer wire is directly proportional to length of the wire of that portion.

Here, $V/l = K$ is called potential gradient, i.e., the fall of potential per unit length of wire.

12.7 Determination of Potential Difference using Potentiometer

A battery of emf ϵ is connected between the end terminals A and B of potentiometer wire with ammeter A_1 , resistance box R and key K in series. This circuit is called an auxiliary circuit. The ends of resistance R_1 are connected to terminals A and Jockey J through galvanometer G . A cell ϵ_1 and key K_1 are connected across R_1 as shown in figure.

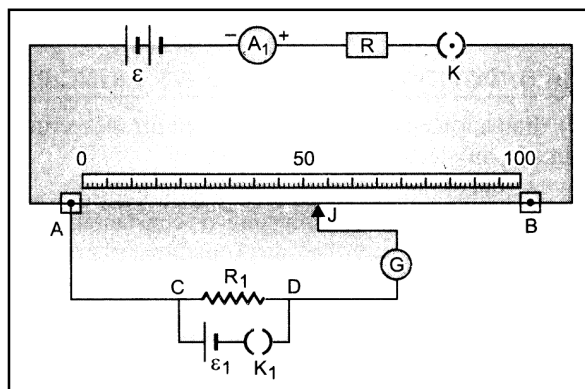

Working and Theory : Close key K and take out suitable resistance R from resistance box so that the fall of potential across the potentiometer wire is greater than the potential difference to be measured.

It can be checked by pressing, firstly the jockey J on potentiometer wire near end A and later on near end B, the deflections in galvanometer are in opposite directions.

Close key K_1 . The current flows through R_1 . A potential difference is developed across R_1 . Adjust the position of jockey on potentiometer wire where if pressed, the galvanometer shows no deflection. Let it be when jockey is at J . Note the length $AJ (= l)$ of potentiometer wire. This would happen when potential difference across R_1 is equal to the fall of potential across the potentiometer wire of length l . If K is the potential gradient of potentiometer wire, then potential difference across R_1 , i.e.,

$$V = Kl$$

If r is the resistance of potentiometer wire of length L , then current through potentiometer wire is

$$I = \frac{\epsilon}{R + r}$$

$$\text{Potential drop across potentiometer wire} = Ir = \left(\frac{\epsilon}{R + r} \right) r$$

Potential gradient of potentiometer wire, i.e., fall of potential per unit length is

$$K = \left(\frac{\epsilon}{R + r} \right) \frac{r}{L} \quad \boxed{V = \left(\frac{\epsilon}{R + r} \right) \frac{r}{L} \ell}$$

Hence, V can be calculated.

12.8 Comparison of emfs of two cells using Potentiometer

A battery of emf ϵ is connected between the end terminals A and B of potentiometer wire with rheostat R_h , ammeter A_1 and key K in series.

The positive terminals of both the cells are connected to point A of the potentiometer. Their negative terminals are connected to two terminals 1 and 2 of two ways key, while its common terminal 3 is connected to jockey J through a galvanometer G .

Insert the plug in the gap between the terminals 1 and 3 of two way key so that the cell of emf ϵ_1 is in the circuit.

Adjust the position of jockey on potentiometer wire, where if pressed, the galvanometer shows no deflection. Let it be when jockey be at J_1 . Note the length AJ_1 ($= l_1$ say) of the wire.

There is no current in arm $A\epsilon_1 J_1$. It means the potential of positive terminal of cell = potential of the point A, and the potential of negative terminal of cell = potential of the point J_1 .

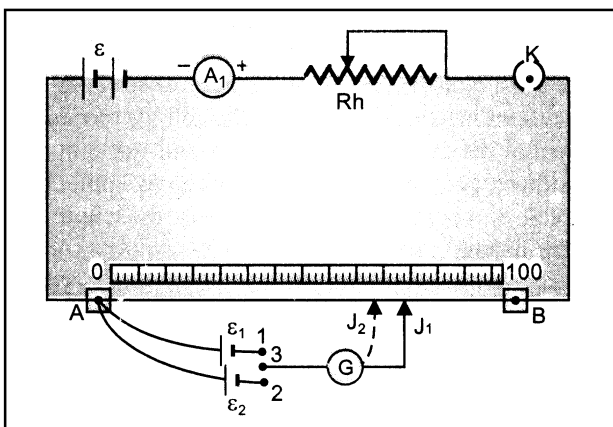

Therefore, the e.m.f. of the cell ($= \epsilon_1$) is equal to potential difference between the points A and J_1 of the potentiometer wire.

$$\text{i.e., } \epsilon_1 = Kl_1 \quad \dots(1)$$

where K is the potential gradient across the potentiometer wire.

Now remove the plug from the gap between 1 and 3 and insert in the gap between 2 and 3 of two way key so that cells of emf ϵ_2 comes into the circuit. Again find the position of jockey on potentiometer wire, where galvanometer shows no deflection. Let it be at J_2 . Note the length of the wire AJ_2 ($= l_2$ say). Then

$$\epsilon_2 = Kl_2 \quad \dots(2)$$

$$\text{Dividing (1) by (2), we get } \frac{\epsilon_1}{\epsilon_2} = \frac{l_1}{l_2}$$

12.9 Precautions of experiment

1. The current in the potentiometer wire from driving cell must be kept constant during experiment.
2. While adjusting the position of jockey on potentiometer wire, the edge of jockey should not be rubbed on the wire, otherwise area of cross-section of wire will not be uniform and constant.
3. The current in the potentiometer wire from driving cell should not be passed for long time as this would cause heating effect, resulting the change in resistance of wire.

Memory note

A balance point is obtained on the potentiometer wire if the fall of potential along the potentiometer wire, due to driving cell is greater than the e.m.f. of the cells to be balanced.

12.10 Determination of Internal Resistance of a Cell by Potentiometer Method

To find the internal resistance r of a cell of emf ϵ using potentiometer, set up the circuit as shown in figure.

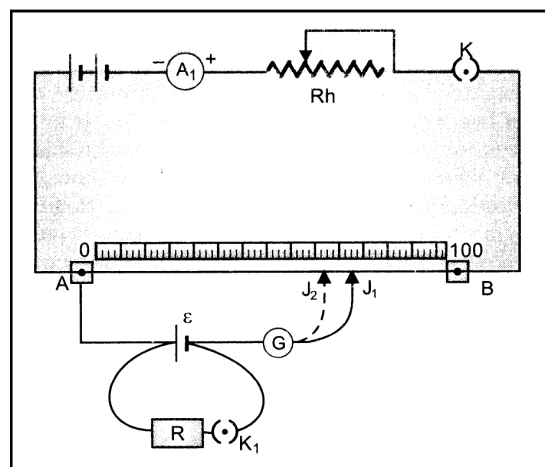

Close key K and maintain suitable constant current in the potentiometer wire with the help of rheostat Rh. Adjust the position of jockey on the potentiometer wire where if pressed, the galvanometer show no deflection. Let it be when jockey is as J_1 . Note the length $AJ_1 (= l_1)$ of the potentiometer wire. Now emf of the cell, $\varepsilon =$ potential difference across the length l_1 of the potentiometer wire.

$$\text{or } \varepsilon = Kl_1 \quad \dots(1)$$

where K is the potential gradient across the wire.

Close key K_1 and take out suitable resistance R from the resistance box in the cell circuit. Again find the position of the jockey on the potentiometer wire where galvanometer shows no deflection. Let it be at J_2 . Note the length of the wire $AJ_2 (= l_2)$ say. As current is being drawn from the cell, its terminal potential difference V is balanced and not emf ε . Therefore, potential difference between two poles of the cell, $V =$ potential difference across the length l_2 of the potentiometer wire

$$\text{i.e. } V = Kl_2 \quad \dots(2)$$

Dividing (1) by (2), we have

$$\frac{\varepsilon}{V} = \frac{l_1}{l_2} \quad \dots(3)$$

We know that the internal resistance r of a cell of emf ε , when a resistance R is connected in its circuit is given by

$$r = \frac{\varepsilon - V}{V} \times R = \left(\frac{\varepsilon}{V} - 1 \right) R \quad \dots(4)$$

Putting the value (3) in (4), we get

$$r = \left(\frac{l_1}{l_2} - 1 \right) R = \frac{l_1 - l_2}{l_2} \times R$$

Thus, knowing the values of l_1, l_2 and R, the internal resistance r of the cell can be determined.

12.11 Sensitiveness of Potentiometer

The sensitiveness of potentiometer means the smallest potential difference that can be measured with its help.

The sensitiveness of a potentiometer can be increased by decreasing its potential gradient. The same can be achieved.

- (i) By increasing the length of potentiometer wire.
- (ii) If the potentiometer wire is of fixed length, the potential gradient can be decreased by reducing the current in the

potentiometer wire circuit with the help of rheostat and using a single cell.

Difference between Potentiometer and Voltmeter

Potentiometer	Voltmere
1. It measures the emf of a cell very accurately.	1. It measures the emf of a cell approximately.
2. While measuring emf it does not draw any current from the source of known emf.	2. While measuring emf, it drws some current from the source of emf.
3. While measuring emf, the resistance of potentiometer becomes infinite.	3. While measuring emf the resistance of voltmeter is high but finite.
4. Its sensitivity is high.	4. Its sensitivity is low.
5. It is based on null deflection method.	5. It is based on deflection method.
6. It can be used for various purposes.	6. It can be used only to measure emf or potential difference.

13. HEATING EFFECT OF CURRENT

When some potential difference V is applied across a resistance R then the work done by the electric field on charge q to flow through the circuit in time t will be

$$W = qV = Vit = i^2Rt = \frac{V^2t}{R} \text{ Joule .}$$



This work appears as thermal energy in the resistor.

Heat produced by the resistance R is

$$H = \frac{W}{J} = \frac{Vit}{4.2} = \frac{i^2Rt}{4.2} = \frac{V^2t}{4.2R} \text{ Cal. This relation is called joules}$$

heating.

Some important relations for solving objective questions are as follow :

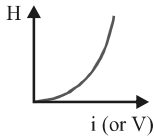
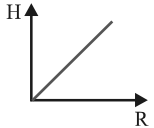
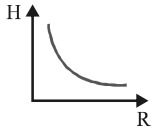
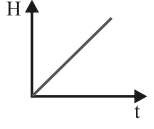
Condition	Graph
If R and t are constant $H \propto i^2$ and $H \propto V^2$	
If i and t are constant (series grouping) $H \propto R$	
If V and t are constant (Parallel grouping) $H \propto \frac{1}{R}$	
If V, i and R constant $H \propto t$	

13.1 Electric Power

The rate at which electrical energy is dissipated into other forms of energy is called electrical power i.e.

$$P = \frac{W}{t} = Vi = i^2R = \frac{V^2}{R}$$

- Units : It's S.I. unit is Joule/sec or Watt
Bigger S.I. units are KW, MW and HP,
remember 1 HP = 746 Watt
- Rated values : On electrical appliances
(Bulbs, Heater ... etc.)

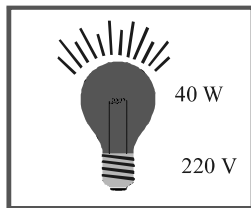

Wattage, voltage, etc. are printed called rated values e.g. If suppose we have a bulb of 40 W, 220 V then rated power (P_R) = 40 W while rated voltage (V_R) = 220 V. It means that on operating the bulb at 220 volt, the power dissipated will be 40 W or in other words 40 J of electrical energy will be converted into heat and light per second.

- Resistance of electrical appliance : If variation of resistance with temperature is neglected then resistance

of any electrical appliance can be calculated by rated power and rated voltage i.e. by using $R = \frac{V_R^2}{P_R}$ e.g.

Resistance of 100W, 220 volt bulb is $R = \frac{220 \times 220}{100} = 484 \Omega$

- Power consumed (illumination) : An electrical appliance (Bulb, heater, etc.) consume rated power (P_R) only if applied voltage (V_A) is equal to rated voltage (V_R) i.e. If

$V_A = V_R$ so $P_{\text{consumed}} = P_R$. If $V_A < V_R$ then $P_{\text{consumed}} = \frac{V_A^2}{R}$

also we have $R = \frac{V_R^2}{P_R}$ so

$$P_{\text{consumed}} (\text{Brightness}) = \left(\frac{V_A^2}{V_R^2} \right) \cdot P_R$$

$P_{\text{consumed}} \propto (\text{Brightness})$

- e.g. If 100 W, 220 V bulb operates on 110 volt supply then

$$P_{\text{consumed}} = \left(\frac{110}{220} \right)^2 \times 100 = 25 \text{ W}$$

Note...

If $V_A < V_R$ then % drop in output power

$$= \frac{(P_R - P_{\text{consumed}})}{P_R} \times 100$$

For the series combination of bulbs, current through them will be same so they will consume power in the ratio of resistance i.e., $P \propto R$ {By $P = i^2R$ } while if they are connected in parallel i.e. V is constant so power consumed by them is in the reverse ratio of their resistance i.e. $P \propto \frac{1}{R}$

- Thickness of filament of bulb :** We know that resistance

of filament of bulb is given by $R = \frac{V_R^2}{P_R}$, also $R = \rho \frac{l}{A}$,

hence we can say that $\frac{A}{(\text{Thickness})} \propto P_R \propto \frac{1}{R}$ i.e. If rated

power of a bulb is more, thickness of it's filament is also more and it's resistance will be less.



If applied voltage is constant then $P_{(consumed)} \propto \frac{1}{R}$

(By $P = \frac{V_A^2}{R}$). Hence if different bulbs (electrical appliance) operated at same voltage supply then

$$P_{consumed} \propto P_R \propto \text{thickness} \propto \frac{1}{R}$$

Note...

Different bulbs

25W 100W 1000W
220V 220V 220V



- ⇒ Resistance $R_{25} > R_{100} > R_{1000}$
- ⇒ Thickness of filament $t_{1000} > t_{100} > t_{25}$
- ⇒ Brightness $B_{1000} > B_{100} > B_{25}$

(6) **Long distance power transmission :** When power is transmitted through a power line of resistance R , power loss will be $i^2 R$

Now if the power P is transmitted at voltage V

$$P = V_i \text{ i.e. } i = (P/V) \text{ So, Power loss} = \frac{P^2}{V^2} \times R$$

Now as for a given power and line, P and R are constant so Power loss $\propto (1/V^2)$

So if power is transmitted at high voltage, power loss will be small and vice-versa. e.g., power loss at 22 kV is 10^{-4} times than at 220 V. This is why long distance power transmission is carried out at high voltage.

(7) Time taken by heater to boil the water : We know that heat required to raise the temperature $\Delta\theta$ of any substance of mass m and specific heat S is $H = m.S.\Delta\theta$
Here heat produced by the heater = Heat required to raise the temp. $\Delta\theta$ of water.

$$i.e. p \times t = J \times m.S.\Delta\theta \Rightarrow t = \frac{J(m.S.\Delta\theta)}{p}$$

$$\{J = 4.18 \text{ or } 4.2 \text{ J/cal}\}$$

$$\text{for } m \text{ kg water } t = \frac{4180 \text{ (or } 4200) m \Delta\theta}{p}$$

$$\{S = 1000 \text{ cal/kg}^\circ\text{C}\}$$

Note...

If quantity of water is given n litre then

$$t = \frac{4180(4200)n\Delta\theta}{p}$$

13.2 Electric Energy

The total electric work done or energy supplied by the source of emf in maintaining the current in an electric circuit for a given time is called electric energy consumed in the circuit.

$$\therefore \text{Electric energy, } W = VI t = P.t$$

$$\therefore \text{Electric energy} = \text{electric power} \times \text{time}$$

SI unit of electric energy is joule, where

$$1 \text{ joule} = 1 \text{ volt} \times 1 \text{ ampere} \times 1 \text{ second} = 1 \text{ watt} \times 1 \text{ second}$$

The commercial unit of electric energy is called a kilowatt-hour (kWh) or Board to Trade Unit (BOT) or UNIT of Electricity, in brief, where

$$1 \text{ kWh} = 1 \text{ kilo watt} \times 1 \text{ hour} = 1000 \text{ watt} \times 1 \text{ hour}$$

Thus 1 kilo watt hour is the total electric energy consumed when an electrical appliance of power 1 kilo-watt works for one hours.

$$1 \text{ kWh} = 1000 \text{ Wh} = (1000 \text{ W}) \times (60 \times 60 \text{ s}) = 3.6 \times 10^6 \text{ J.}$$

Note that the number of units of electricity consumed = No.

$$\text{of kWh} = \frac{\text{watt} \times \text{hour}}{1000}$$

$$\text{Electric energy} = VI t = I^2 R t = V^2 t / R$$

13.3 Electricity Consumption

- (1) The price of electricity consumed is calculated on the basis of electrical energy and not on the basis of electrical power.
- (2) The unit Joule for energy is very small hence a big practical unit is considered known as kilowatt hour (KWH) or board of trade unit (B.T.U.) or simple unit.
- (3) 1 KWH or 1 unit is the quantity of electrical energy which dissipates in one hour in an electrical circuit when the electrical power in the circuit is 1 KWH thus
 $1 \text{ KWH} = 1000 \text{ W} \times 3600 \text{ sec} = 3.6 \times 10^6 \text{ J.}$



(4) Important formulae to calculate the no. of consumed units

$$\text{is } n = \frac{\text{Total watt} \times \text{Total hours}}{1000}$$

13.4 Combination of Bulbs (or Electrical Appliances)

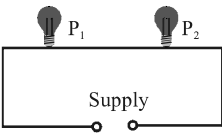
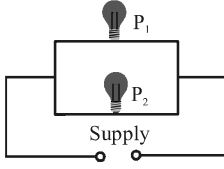
Bulbs (Heater etc.) are in series	Bulbs (Heater etc.) are in parallel
<p>(1) Total power consumed</p> $\frac{1}{P_{\text{total}}} = \frac{1}{P_1} + \frac{1}{P_2} + \dots$ 	<p>(1) Total power consumed</p> $P_{\text{total}} = P_1 + P_2 + P_3 \dots + P_n$ 
<p>(2) In 'n' bulbs are identical,</p> $P_{\text{total}} = \frac{P}{N}$ <p>P_{consumed} (Brightness)</p> $\propto V \propto R \propto \frac{1}{P_{\text{rated}}}$ <p>i.e. in series combination bulb of lesser wattage will give more bright light and p.d. appeared across it will be more.</p>	<p>(2) If 'n' identical bulbs are in parallel. $P_{\text{total}} = nP$</p> <p>P_{consumed} (Brightness)</p> $\propto P_R \propto i \propto \frac{1}{R}$ <p>i.e. in parallel combination bulb of greater wattage will give more bright light and more current will pass through it.</p>

Some Standard Cases for Series and Parallel Combination

- (1) If n identical bulbs first connected in series so $P_s = \frac{P}{n}$ and then connected in parallel. So $P_p = nP$ hence $\frac{P_p}{P_s} = n^2$
- (2) An electric kettle has two coils when one coil is switched on it takes time t_1 to boil water and when the second coil is switched on it takes time t_2 to boil the same water.

<p>If they are connected in series</p> $\frac{1}{P_s} = \frac{1}{P_1} + \frac{1}{P_2}$ $\Rightarrow \frac{1}{H_s/t_s} = \frac{1}{H_1/t_1} + \frac{1}{H_2/t_2}$ $\therefore H_s = H_1 = H_2$ <p>so $t_s = t_1 + t_2$</p> <p>i.e. time taken by combination to boil the same quantity of water</p> $t_s = t_1 + t_2$	<p>If they are connected in parallel</p> $P_p = P_1 + P_2$ $\Rightarrow \frac{H_p}{t_p} = \frac{H_1}{t_1} + \frac{H_2}{t_2}$ $\therefore H_p = H_1 = H_2$ <p>so $\frac{1}{t_p} = \frac{1}{t_1} + \frac{1}{t_2}$</p> <p>i.e. time taken by parallel combination to boil the same quantity of water</p> $t_p = \frac{t_1 t_2}{t_1 + t_2}$
---	--

(3) If three identical bulbs are connected in series as shown in figure then on closing the switch S. Bulb C short circuited and hence illumination of bulbs A and B increases

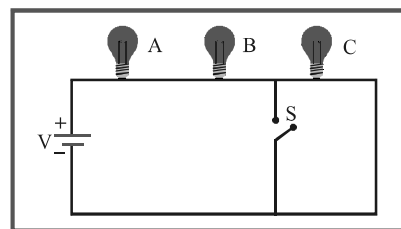

Reason : Voltage on A and B increased.

(4) If three bulbs A, B and C are connected in mixed combination as shown, then illumination of bulb A decreases if either B or C gets fused

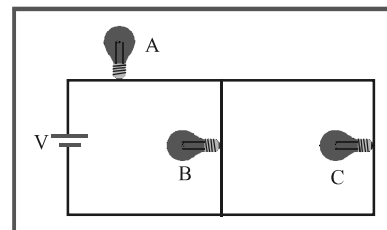

Reason : Voltage on A decreases.

(5) If two identical bulb A and B are connected in parallel with ammeter A and key K as shown in figure.

It should be remembered that on pressing key reading of ammeter becomes twice.

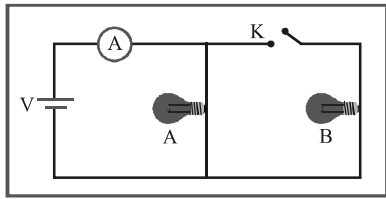

Reason : Total resistance becomes half.

Concepts

When a heavy current appliance such as motor, heater or geyser is switched on, it will draw a heavy current from the source so that terminal voltage of source decreases. Hence power consumed by the bulb decreases, so the light of bulb becomes less.

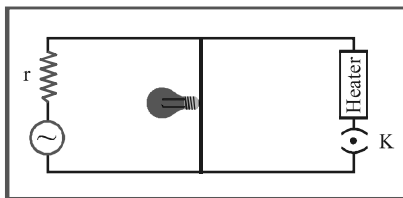

13.5 Some aspects of heating effects of current

1. The wire supplying current to an electric lamp are not practically heated while the filament of lamp becomes white hot.

We know that in series connections the heat produced due to a current in a conductor is proportional to its resistance (i.e. $H \propto R$). The filament of the lamp and the supply wires are in series. The resistance of the wire supplying the current to the lamp is very small as compared to that of the filament of the lamp. Therefore, there is more heating effect in the filament of the lamp than that in the supply wires. Due to it, the filament of the lamp becomes white hot whereas the wires remain practically unheated.

2. Electric Iron
3. Electric Arc
4. Incandescent electric lamp

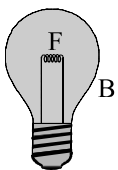

5. Fuse wire

14. ELECTRICAL CONDUCTING MATERIALS FOR SPECIFIC USE

- (1) **Filament of electric bulb :** Is made up of tungsten which has high resistivity, high melting point.
- (2) **Element of heating devices (such as heater, geyser or press) :** Is made up of nichrome which has high resistivity and high melting point.
- (3) **Resistances of resistance boxes (standard resistances) :** Are made up of alloys (manganin, constantan or nichrome) these materials have moderate resistivity which is practically independent of temperature so that the specified value of resistance does not alter with minor changes in temperature.
- (4) **Fuse-wire :** Is made up of tin-lead alloy (63% tin + 37% lead). It should have low melting point and high resistivity. It is used in series as a safety device in an electric circuit and is designed so as to melt and thereby open the circuit if the current exceeds a predetermined value due to some fault. The function of a fuse is independent of its length.

Safe current of fuse wire relates with its radius as $i \propto r^{3/2}$

- (5) **Thermistors :** A thermistor is a heat sensitive resistor usually prepared from oxides of various metals such as nickel, copper, cobalt, iron etc. These compounds are also semi-conductor. For thermistors α is very high which may be positive or negative. The resistance of thermistors changes very rapidly with change of temperature.

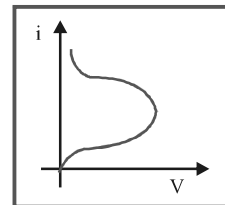

Thermistors are used to detect small temperature change and to measure very low temperature.

15. SUPER CONDUCTIVITY

Prof. K. Onnes, in 1911, discovered that certain metals and alloys at very low temperature lose their resistance considerably. This phenomenon is known as **super-conductivity**. As the temperature decreases, the resistance of the material also decreases, but when the temperature reaches a certain critical value (called **critical temperature or transition temperature**), the resistance of the material completely disappears i.e., it becomes zero. Then the material behaves as if it is a **super-conductor** and there will be flow of electrons without any resistance whatsoever. The critical temperature is different for different materials. It has been found

that mercury at critical temperature 4.2 K, lead at 7.25 K and niobium at critical temperature 9.2 K become super-conductors.

A team of scientists discovered that an alloy of plutonium, cobalt and gallium exhibits super conductivity at temperatures below 18.5 K. Since 1987, many superconductors have been prepared with critical temperature upto 125 K, as listed below

$\text{Bi}_2\text{Ca}_2\text{Sr}_2\text{Cu}_3\text{O}_{10}$ at 105 K and $\text{Tl}_2\text{Ca}_2\text{Ba}_2\text{Cu}_3\text{O}_{10}$ at 125 K.

The super-conductivity shown by materials can be verified by simple experiment. If a current is once set up in a closed ring of super-conducting material, it continues flowing for several weeks after the source of e.m.f. has been withdrawn.

The cause of super-conductivity is that, the free electrons in super-conductor are no longer independent but become mutually dependent and coherent when the critical temperature is reached. The ionic vibrations which could deflect free electrons in metals are unable to deflect this coherent or co-operative cloud of electrons in super-conductors. It means the coherent cloud of electrons makes no collisions with ions of the super-conductor and, as such, there is no resistance offered by the super-conductor to the flow of electrons.

Super-conductivity is a very interesting field of research all over the world these days. The scientists have been working actively to prepare super-conductor at room temperature and they have met with some success only.

Application of super conductors

1. Super conductors are used for making very strong electromagnets.
2. Super conductivity is playing an important role in material science research and high energy partical physics.
3. Super conductivity is used to produce very high speed computers.
4. Super conductors are used for the transmission of electric power.

TIPS AND TRICKS

1. Human body, though has a large resistance of the order of $\text{k}\Omega$ (say $10 \text{ k}\Omega$), is very sensitive to minute currents even as low as a few mA . Electrocutation, excites and disorders the nervous system of the body and hence one fails to control the activity of the body.
2. dc flows uniformly throughout the cross-section of conductor while ac mainly flows through the outer surface area of the conductor. This is known as skin effect.
3. It is worth noting that electric field inside a charged conductor is zero, but it is non zero inside a current carrying conductor and is given by $E = \frac{V}{\ell}$ where

V = potential difference across the conductor and ℓ = length of the conductor. Electric field out side the current carrying conductor is zero.

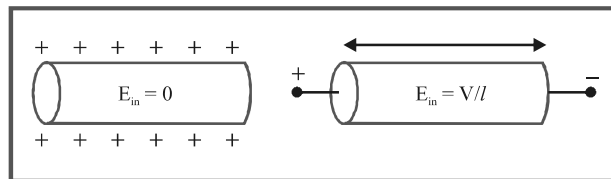

4. For a given conductor $JA = i = \text{constant}$ so that $J \propto \frac{1}{A}$
i.e., $J_1 A_1 = J_2 A_2$; this is called equation of continuity

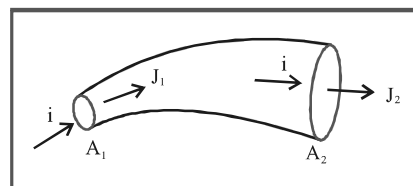

5. The drift velocity of electrons is small because of the frequent Collisions suffered by electrons.
6. The small value of drift velocity produces a large amount of electric current, due to the presence of extremely large number of free electrons in a conductor. The propagation of current is almost at the speed of light and involves electromagnetic process. It is due to this reason that the electric bulb glows immediately when switch is on.
7. In the absence of electric field, the paths of electrons between successive collisions are straight line while in presence of electric field the paths are generally curved.
8. Free electron density in a metal is given by $n = \frac{N_A \times d}{A}$
where N_A = Avogadro number, x = number of free electrons per atom, d = density of metal and A = Atomic weight of metal.
9. In the absence of radiation loss, the time in which a fuse will melt does not depends on it's length but varies with radius as $t \propto r^4$
10. If length (ℓ) and mass (m) of a conducting wire is given
then $R \propto \frac{\ell^2}{m}$
11. Macroscopic form of Ohm's law is $R = \frac{V}{i}$, while it's microscopic form is $J = \sigma E$.
12. After stretching if length increases by n times then resistance will increase by n^2 times i.e. $R_2 = n^2 R_1$

Similarly if radius be reduced to $1/n$ times then area of cross-section decreases $1/n^2$ times so the resistance becomes n^4 times *i.e.* $R_2 = n^4 R_1$

13. After stretching if length of a conductor increases by $x\%$ then resistance will increase by $2x\%$ (valid only if $x < 10\%$)
14. Decoration of lightning in festivals is an example of series grouping whereas all household appliances connected in parallel grouping.
15. Using n conductors of equal resistance, the number of possible combinations is $2^n - 1$.
16. If the resistance of n conductors are totally different, then the number of possible combinations will be 2^n .
17. If n identical resistances are first connected in series and then in parallel, the ratio of the equivalent resistance is

given by $\frac{R_p}{R_s} = \frac{n^2}{1}$

18. If a wire of resistance R , cut in n equal parts and then these parts are collected to form a bundle then equivalent

resistance of combination will be $\frac{R}{n^2}$.

19. If equivalent resistance of R_1 and R_2 in series and parallel be R_s and R_p respectively then

$$R_1 = \frac{1}{2} \left[R_s + \sqrt{R_s^2 - 4R_s R_p} \right] \text{ and}$$

$$R_2 = \frac{1}{2} \left[R_s - \sqrt{R_s^2 - 4R_s R_p} \right]$$

20. If a skeleton cube is made with 12 equal resistance each having resistance R then the net resistance across

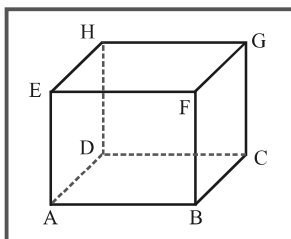

21. The longest diagonal (EC or AG) = $\frac{5}{6} R$
22. The diagonal of face (*e.g.* AC , ED , ...) = $\frac{3}{4} R$
23. A side (*e.g.* AB , BC) = $\frac{7}{12} R$

24. Resistance of a conducting body is not unique but depends on its length and area of cross-section *i.e.* how the potential difference is applied. See the following figures

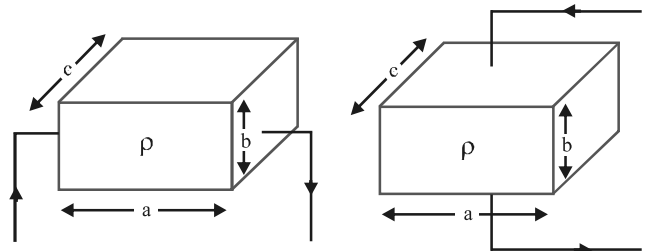

Length = a

Area of cross-section = $b \times c$

$$\text{Resistance } R = \rho \left(\frac{a}{b \times c} \right)$$

Length = b

Area of cross-section = $a \times c$

$$\text{Resistance } R = \rho \left(\frac{b}{a \times c} \right)$$

25. Some standard results for equivalent resistance

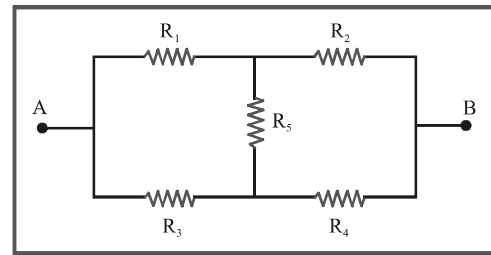

$$R_{AB} = \frac{R_1 R_2 (R_3 + R_4) + (R_1 + R_2) R_3 R_4 + R_5 (R_1 + R_2) (R_3 + R_4)}{R_5 (R_1 + R_2 + R_3 + R_4) + (R_1 + R_3) (R_2 + R_4)}$$

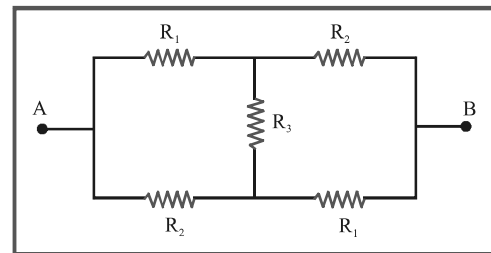

$$R_{AB} = \frac{2R_1 R_2 + R_3 (R_1 + R_2)}{2R_3 + R_1 + R_2}$$

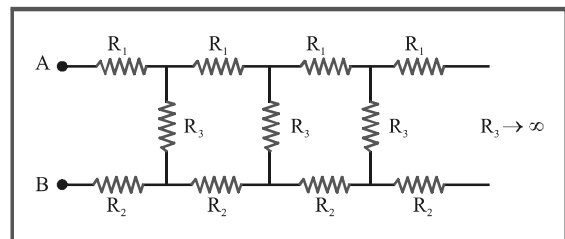

$$R_{AB} = \frac{1}{2}(R_1 + R_2) + \frac{1}{2}[(R_1 + R_2)^2 + 4R_3(R_1 + R_2)]^{1/2}$$

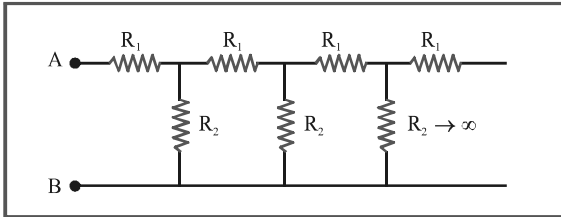

$$R_{AB} = \frac{1}{2}R_1 \left[1 + \sqrt{1 + 4\left(\frac{R_2}{R_1}\right)} \right]$$

26. It is a common misconception that “current in the circuit will be maximum when power consumed by the load is maximum.”
27. Actually current $i = E/(R + r)$ is maximum ($= E/r$) when $R = \min = 0$ with $P_L = (E/r)^2 \times 0 = 0$ min. while power consumed by the load $E^2R/(R + r)^2$ is maximum ($= E^2/4r$) when $R = r$ and $i = (E/2r) \neq \max (= E/r)$.
28. Emf is independent of the resistance of the circuit and depends upon the nature of electrolyte of the cell while potential difference depends upon the resistance between the two points of the circuit and current flowing through the circuit.
29. Whenever a cell or battery is present in a branch there must be some resistance (internal or external or both) present in that branch. In practical situation it always happen because we can never have an ideal cell or battery with zero resistance.
30. In series grouping of identical cells. If one cell is wrongly connected then it will cancel out the effect of two cells e.g. If in the combination of n identical cells (each having emf E and internal resistance r) if x cell are wrongly connected then equivalent emf $E_{eq} = (n - 2x)E$ and equivalent internal resistance $r_{eq} = nr$
31. Graphical view of open circuit and closed circuit of a cell.

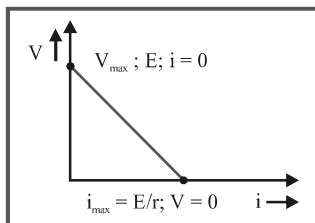

32. If n identical cells are connected in a loop in order, then emf between any two points is zero.

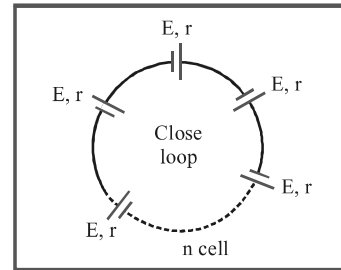

33. In parallel grouping of two identical cell having no internal resistance

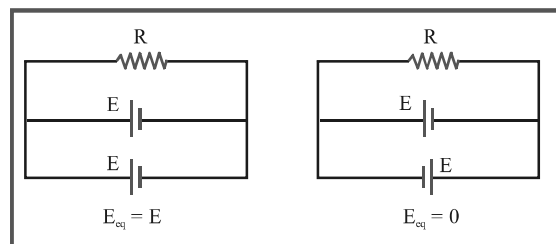

34. When two cell's of different emf and no internal resistance are connected in parallel then equivalent emf is indeterminate, note that connecting a wire with a cell with no resistance is equivalent to short circuiting. Therefore the total current that will be flowing will be infinity.

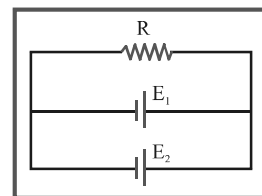

35. In the parallel combination of non-identical cell's if they are connected with reversed polarity as shown then equivalent emf

$$E_{eq} = \frac{E_1 r_2 - E_2 r_1}{r_1 + r_2}$$

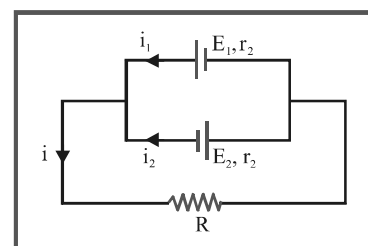



36. Wheatstone bridge is most sensitive if all the arms of bridge have equal resistances *i.e.* $P = Q = R = S$
37. If the temperature of the conductor placed in the right gap of metre bridge is increased, then the balancing length decreases and the jockey moves towards left.
38. In Wheatstone bridge to avoid inductive effects the battery key should be pressed first and the galvanometer key afterwards.
39. The measurement of resistance by Wheatstone bridge is not affected by the internal resistance of the cell.
40. In case of zero deflection in the galvanometer current flows in the primary circuit of the potentiometer, not in the galvanometer circuit.
41. A potentiometer can act as an ideal voltmeter.